



# **QUICK BGA2005**

## **BGA/SMD Rework System**

# **Operation Manual**

Thank you for purchasing our BGA/SMD Rework System. The system is exclusively designed for reworking and soldering SMD component. Please carefully read this manual before operating the system. Store this manual in a safe, easily accessible place for future reference.

# Table of Contents

1. Summary	1
2. Product picture	2
3. Packing parts	2
4. Instruction of IR2005 Rework System	3
4.1 Specification and Technical Parameter	3
4.1.1 Specification	3
4.1.2 Technical Parameter	3
4.2 IR2005 Picture	4
4.3 Safety Instruction	5
4.4 Connecting and Adjusting	5
4.4.1 Place the system	5
4.4.2 Connect the system	5
4.4.3 Parts function adjusting	6
4.5 Keyboard function and Parameter setting Instruction	7
4.5.1 Instruction of Keyboard	7
4.5.2 Parameter setting	8
A. Input Password	8
B. Modify working flow	9
C. Modify working mode	9
D. Modify laser alignment mode	14
E. System instruction	15
4.6 Operating technics instruction	15
4.6.1 Instruction of soldering technics	16
4.6.2 Instruction of desoldering technics	17
4.7 Turn off equipment	18
4.8 Maintenance	18

5. Instruction of PL2005 Precision Placement System .....	19
5.1 Specification .....	19
5.2 Picture .....	20
5.3 Place equipment .....	20
5.4 Install and Connect .....	20
5.4.1 Install RPC .....	21
5.4.2 Place IR2005 Rework System.....	21
5.4.3 Parts connecting .....	21
5.4.4 Power connecting .....	23
5.5 Keyboard and Parts .....	23
5.5.1 Keyboard function .....	23
5.5.2 Parts using .....	23
1. PCB fixture .....	23
2. Adjusting knob .....	24
3. RPC .....	24
4. PL Camera .....	25
5.6 Operating technics instruction .....	25
5.7 Turn off equipment .....	26
5.8 Calibrate System .....	26
5.8.1 Checking .....	26
5.8.2 Adjusting .....	27
5.9 Maintenance .....	27

# 1. Summary

Thank you for using QUICK BGA2005 Rework System. This system adopts micro-processor control and infrared sensor technology to do soldering and de-soldering to surface mount components safely and accurately. Also it can control the whole technical process and record all messages through the IR Soft. It meets the higher technical demands of modern electronic industry, and it is one of the most valued electronic equipments in this field. QUICK BGA2005 consists of two parts, one is QUICK IR2005 Infrared Rework System, and the other is QUICK PL2005 Precision Placement System.

QUICK IR2005 Rework System adopts micro-processor control and infrared sensor technology. It has the precision non-contact infrared temperature sensor for de-soldering parts and the middle wavelength infrared heater. The soldering process is under the monitoring of non-contact infrared sensor and optimum control of process can be achieved at any time. In order to get the best technical control and the non-destruction of process and the reproductive PCB temperature, IR 2005 supplies a 1600W heating power, suitable for application of big or small PCB as well as and lead-free application. The technology of re-flow soldering controlled by closed-loop ensures the precision technical window, even heat distribution and appropriate peak value of temperature for lead-free soldering.

The middle-wavelength infrared heater of IR 2005 has a well-proportioned and safe heating and power and flexibility necessary for the system, so it can also deal with some PCBs with big thermal capacity and other high temperature situation (lead-free soldering) easily. The adjustable aperture under the infrared radiator can protect the adjacent components (which are sensitive to the temperature) on PCB from being heated. No need for nozzles.

IR 2005 works under the “open environment”, that is to say it can calibrate and test temperature when soldering. When the solder begins to melt, press down the calibrating button to record the melting point temperature of solder. IR 2005 has 10 types work parameter modes, and programmable temperature controlling can modify the parameter of every work modes. Operation and controlling of IR, also the setting of parameter are carried on the keyboard.

The use of reflow process camera, supply the critical message to judge the melting of solder during the whole soldering and desoldering process.

Besides, IR 2005 can cool down the PCB efficiently, together with the intelligent lead-free digital calibrating soldering station, for any professional user, it is a integrated and perfect soldering equipment.

PL2005 precision placement system provides exact controlling alignment for soldering technics of IR2005 rework system. Exact fine-adjustment and fine alignment information what camera provides ensures IR2005's exact soldering. PL2005 uses a keyboard to control the operation. Combine IR2005 and RPC2005 to constitute a suit of integrated BGA rework system. It creates a top working condition for reworking modern electric product.

## 2. Product Picture

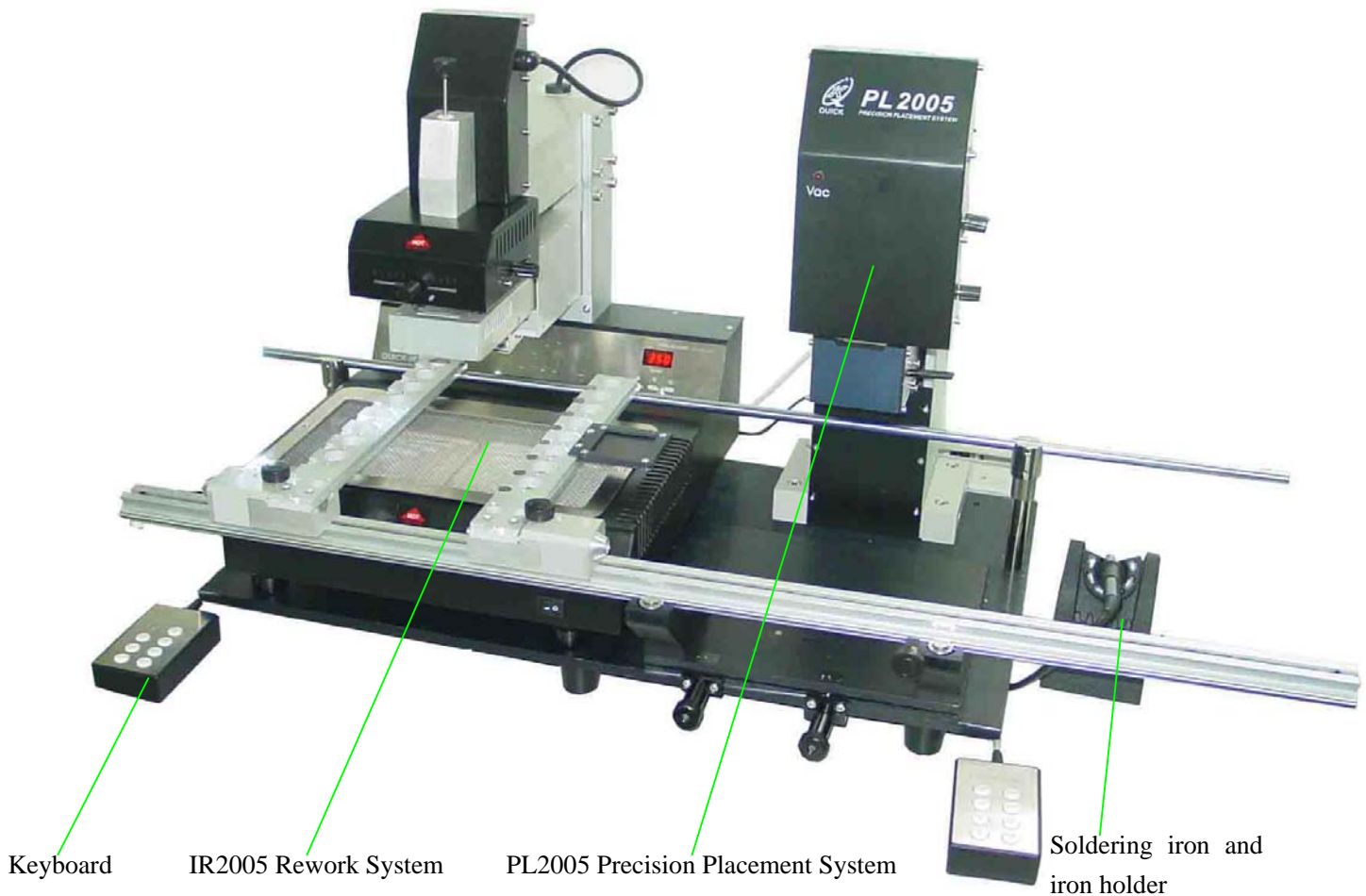

## 3. Packing Parts

Please check whether the following parts are in good condition.

- \* IR2005 Main unit
- \* IR Keyboard
- \* Intelligent lead free soldering iron and Iron holder.
- \* BGA Operation Manual
- \* PL2005 Main unite (PL camera, PL-HEAD, Vacuum parts, Baseboard)
- \* PL Keyboard
- \* Power cord
- \* Monitor (optional)
- \* RPC2005—IR Reflow Process Camera (Optional)
- \* PCB Movement Fixture (Optional)

**Note:** The parts will be packed according to the packing list, if you don't purchase the optional part and it isn't in the package. If any above part is missed out, please contact with our company or agents immediately.

## 4. Instructions of IR2005 Rework System

### 4.1 Specification and Technical Parameter

#### 4.1.1 Specification

1.Max Power	1600W (Max)
2.Power of bottom preheating	2*400W (Infrared ceramic heating plate)
3.Power of top heating	6*130W (Infrared heating tube, Size: 60×60mm)
4.Wavelength of IR radiator	2~8μm Approx
5.Preheating time of bottom IR radiator	90s Approx (Size: 135×250mm)
6.Adjusting rang of top IR radiator	20~60mm
7.Heating time of top IR radiator	Approx 10s (Room Temperature~230℃)
8.Vacuum pump	12V/300mA, 0.05Mpa
9.Bottom cooling fan	12V/90mA 12CFM (crosscurrent fan)
10.Top cooling fan	12V/300mA 15CFM
11.Laser alignment tube	3V/30mA (2 pcs)
12.LCD display screen	Size: 65.7×23.5mm 16×2 character
13.Soldering Iron	Intelligent digital display lead free soldering iron
14.Power of soldering iron	60W
15.Communication	Standard RS-232C (Connect with PC)
16.Keyboard	8 Buttons
17.Upward and downward movement motor	24VDC/100mA
18.Upward and downward movement range	93mm
19.Infrared Temperature sensor	0~300℃ (Testing range)
20.Outside K type sensor	(Optional)
21.Dimension	33×38×44 (cm)
22.Weight	13Kg

**Note:** When purchasing the equipment, please point out the work voltage.

#### 4.1.2 Technical Data

TL: Melting temperature of solder

T1: Heat preservation starting temperature of reflow soldering

T2: Heat preservation ending temperature of reflow soldering

T3: Peak value temperature of soldering and de-soldering

T0: Valve temperature: The lowest temperature of bottom heater when top heater heats ups. T0<TB

TB: The set temperature of bottom heater

Tb: The real time temperature value of bottom heater

TC: The real time temperature value of top heater

S1: Heating time rising from T1 to T2

S2: Heating time rising from T2 to T3

S3: Heat preservation time of T3

**IR 2005 Rework System has ten working modes and its parameter can be changed according to demand. Concrete setting as the following:**

0.	T1=100°C	S1=60s	T2=140°C	S2=40s	T3=200°C	S3=10s	TL=183°C	TB=130°C	T0=60°C
1.	T1=110°C	S1=60s	T2=150°C	S2=30s	T3=200°C	S3=10s	TL=183°C	TB=140°C	T0=90°C
2.	T1=120°C	S1=70s	T2=160°C	S2=25s	T3=200°C	S3=10s	TL=183°C	TB=150°C	T0=90°C
3.	T1=120°C	S1=70s	T2=160°C	S2=30s	T3=205°C	S3=10s	TL=183°C	TB=160°C	T0=100°C
4.	T1=130°C	S1=60s	T2=165°C	S2=25s	T3=200°C	S3=10s	TL=183°C	TB=170°C	T0=90°C
5.	T1=110°C	S1=50s	T2=150°C	S2=30s	T3=200°C	S3=10s	TL=183°C	TB=150°C	T0=60°C
6.	T1=120°C	S1=40s	T2=150°C	S2=30s	T3=195°C	S3=10s	TL=183°C	TB=160°C	T0=60°C
7.	T1=120°C	S1=40s	T2=160°C	S2=30s	T3=205°C	S3=10s	TL=183°C	TB=170°C	T0=90°C
8.	T1=130°C	S1=50s	T2=165°C	S2=30s	T3=210°C	S3=10s	TL=183°C	TB=170°C	T0=90°C
9.	T1=100°C	S1=40s	T2=140°C	S2=40s	T3=200°C	S3=10s	TL=183°C	TB=150°C	T0=90°C

## 4.2 IR2005 Picture

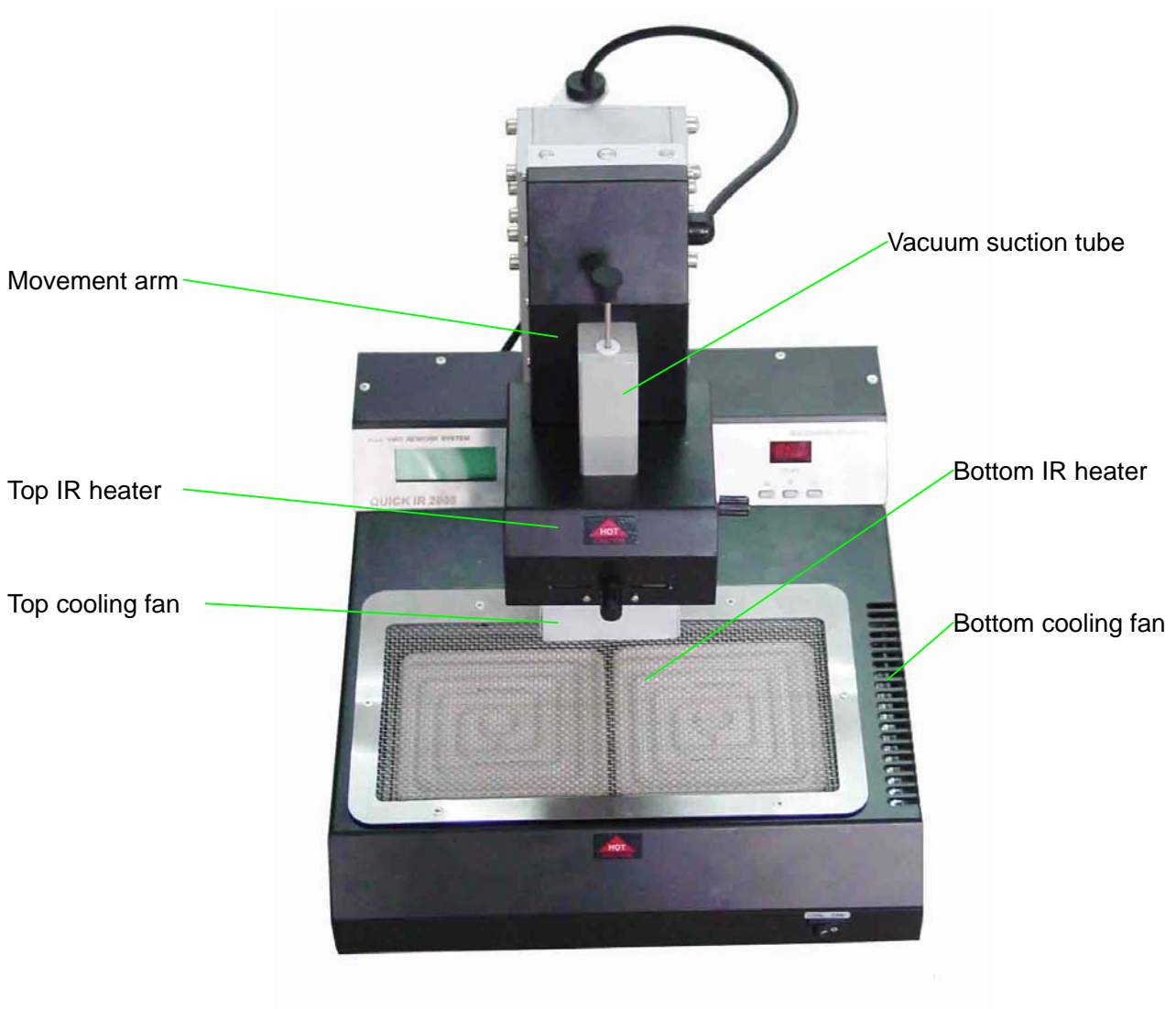

## 4.3 Safety Instructions

Note: For safety of system and operator, please read this manual carefully before operating the unit.

Please note that the unit is suitable for soldering and de-soldering of electronic components.



Note: Top and bottom IR radiator will be very hot during working, so explosive and combustible object or gas and solvent is strictly prohibited in working areas, also please don't touch the hot housing parts



Note: The laser alignment device includes a secondary laser device, so don't see the laser beam directly.



Note: When the system happens trouble and needs maintenance, it should be carried on by a experienced and authorized technician or mavin, or contact with service agent and factory.

The unit with dangerous voltage! The inexperienced work is dangerous for operators.

## 4.4 System connecting and parts adjusting

### 4.4.1 Place the unit

Unwrap the packing of the unit, then take it out and put it on the solid level worktable.



**Note:** Top and bottom IR radiator will be very hot during working, so explosive and combustible object or gas and solvent is strictly prohibited in working areas, also please don't touch the hot housing parts.

### 4.4.2 Connect the unit

- \* Please check whether the voltage power accords with the rated voltage on the equipment nameplate.
  - \* Please check whether switches are turned off. (Set to "0")
  - \* Connect Power cord to the power socket behind equipment.
  - \* Connect keyboard to the keyboard socket behind equipment.
  - \* Connect intelligent lead free soldering iron to the soldering iron socket behind equipment.
  - \* If need, connect K type sensor (optional) to the sensor socket behind equipment.
  - \* If you use IR Soft, please connect the RS232 connecting cord to the RS232 socket behind the unit.
- After all these steps, insert power plug into power socket, and switch on power.



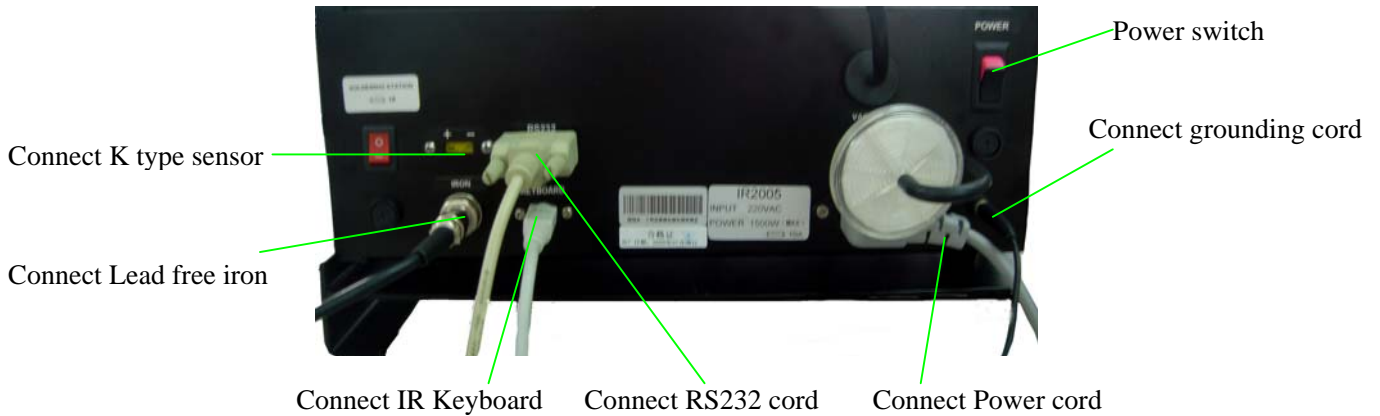

### 4.4.3 Parts adjusting

**\* Adjust the aperture system**

The aperture system of IR radiator on the top of equipment can be adjust from 20×20 (mm) to 60×60 (mm) by two adjustment knobs. Unscrew the knob before adjusting, and adjust the window size, then screw down the knob. The scale “2” on the housing means 20mm and “3” means 30mm, other scale is similar. For example, if you want to adjust it to 50×50 (mm), adjust two knobs to the scale of “5” and screw down them.

**Note:**

Adjusting the aperture system can protect the adjacent components on the PCB from being heated. But, when the aperture system is adjusted to small size, the top IR radiator will become very hot, so it’s necessary to increase the size appropriately to avoid being cut off of the safety switch on top IR radiator.

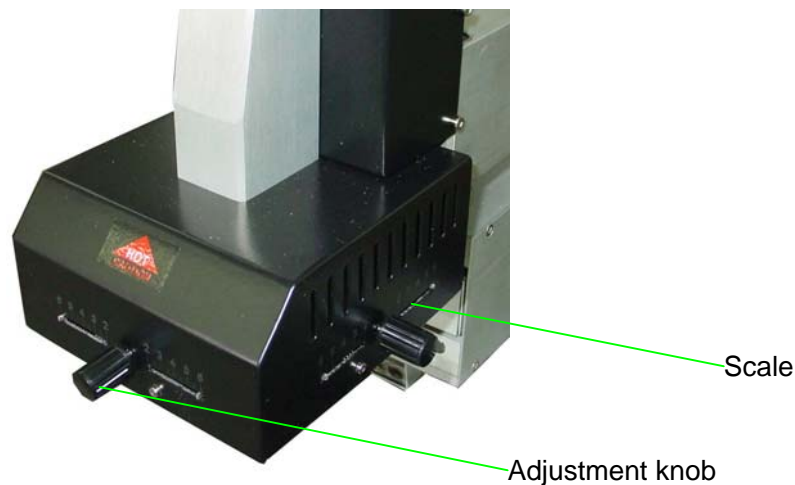

**\* PCB movement fixture (optional)**

Movable PCB fixture is able to fix PCB with different size. It has three Lock Knobs. Two PCB Lock Knobs are used for locking PCB Fixed Bar to prevent it from moving the PCB. The Fixture Lock Knob is used for locking orbit to prevent fixture from moving.

Unscrew PCB Lock Knobs and push the Slide Block by hand to open the PCB Fixed Bar, make the distance accord with PCB size. Fix PCB between them and screw down PCB Lock Knobs after adjusting position. PCB can move forwards ad backwards between Fixed Bars. If you want to lock PCB Fixture, please screw down Fixture Lock Knobs.

**We suggest that when you fix PCB, PCB should be fixed in the middle of orbit.**

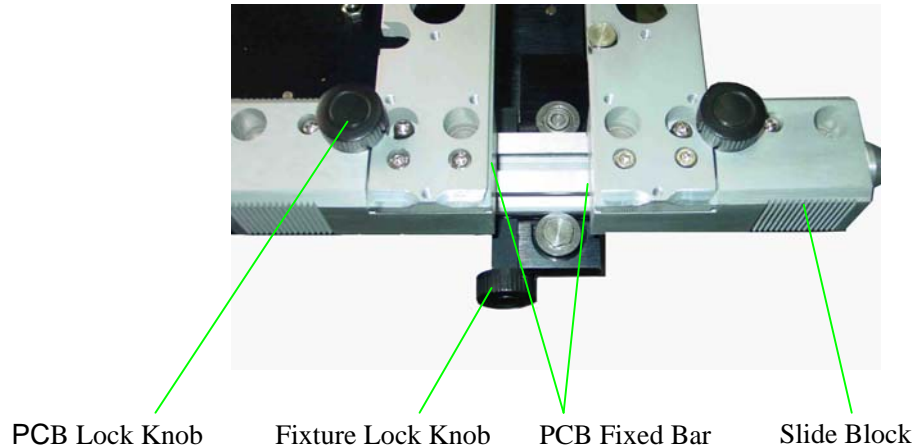

## 4.5 Instructions of keyboard function and parameter setting

### 4.5.1 Instructions of keyboard

- A. During selecting working flow period, “↑” and “↓” keys are used for controlling the moving upward or downward of cursor and increase or decrease of number.  
During the soldering or de-soldering period, also top IR heater haven't yet started to heat up, key “↑” and key “↓” are used for controlling movement upward or downward of top IR heater. That is to say, during movement upward and downward of top IR heater, after pressing the key “BEGIN”, “↑” and “↓” keys make the top heater stop at a proper position.
  - B. Under the standby condition, if the cooling fan have already drawn back, press “↑” and “↓” keys to make the top IR heater move up and down.
  - C. Under the standby condition and the top IR heater is at top position, press “ALIGN” key, the cooling fan (it has laser alignment device inside) will hold out or draw back. When cooling fan completely holds out, the laser alignment device will switch on automatically. After the cooling fan has held out, if you double click “ALIGN” key, the cooling fan will be on or off.
  - D. Function of “SET” key: Make the BGA-IR enter parameters setting mode and cursor move a step forward.
  - E. Function of “EXIT” key: During the setting mode, make BGA-IR cursor exit until exiting the setting mode; During the soldering or de-soldering period, make BGA-IR exit operation.
  - F. Function of “BEGIN” key: During the standby condition, make BGA-IR get into soldering or de-soldering situation.
  - G. Function of “CAL<sub>TL</sub>” Key: During the soldering or de-soldering process, when the temperature increase from T<sub>2</sub> to T<sub>3</sub>, press this key, the current temperature will multiply a coefficient to make TC=TL, calibrating TL. After the flow has finished and come back to initialization, it will save the coefficient.
  - H. Function of “CAL<sub>T3</sub>” Key: During the soldering or de-soldering process, when the temperature increase from T<sub>2</sub> to T<sub>3</sub>, press this key, make the setting value of T<sub>3</sub> change to current temperature TC (T<sub>3</sub>=TC), calibrating T<sub>3</sub>. If press the key continuously, top IR heater will not be limited by the setting value of T<sub>3</sub>, and it heat up until loose the key.
- Note:** If press “CAL<sub>TL</sub>” Key again in the initialization situation, the temperature calibration coefficient of TL comes back to system initialization “1”.

### 4.5.2 Parameter setting

Parameter settings order as the follows:

- A. \_password: \*\*\* (Password settings)
- B. \_select: 0 (Flow settings, it can modify parameter inside.)
- C. \_type: solder (Working mode settings)
- D. \_laser: off (Laser alignment settings)
- E. \_baud: 19200 (Communication speed settings)

#### A. Input password

The initial password of system is “000”. At the same time, system also has the omnipotent password “159”. If you forget the setting password, you can input “159” to make the password of system come back to initial password “000”.

**Note:** If want to modify parameter of system, you must input password, otherwise, you can only browse them.

**For instance: Input the initial password “000” of system.**

When in initial state, TC, Tb display room temperature.

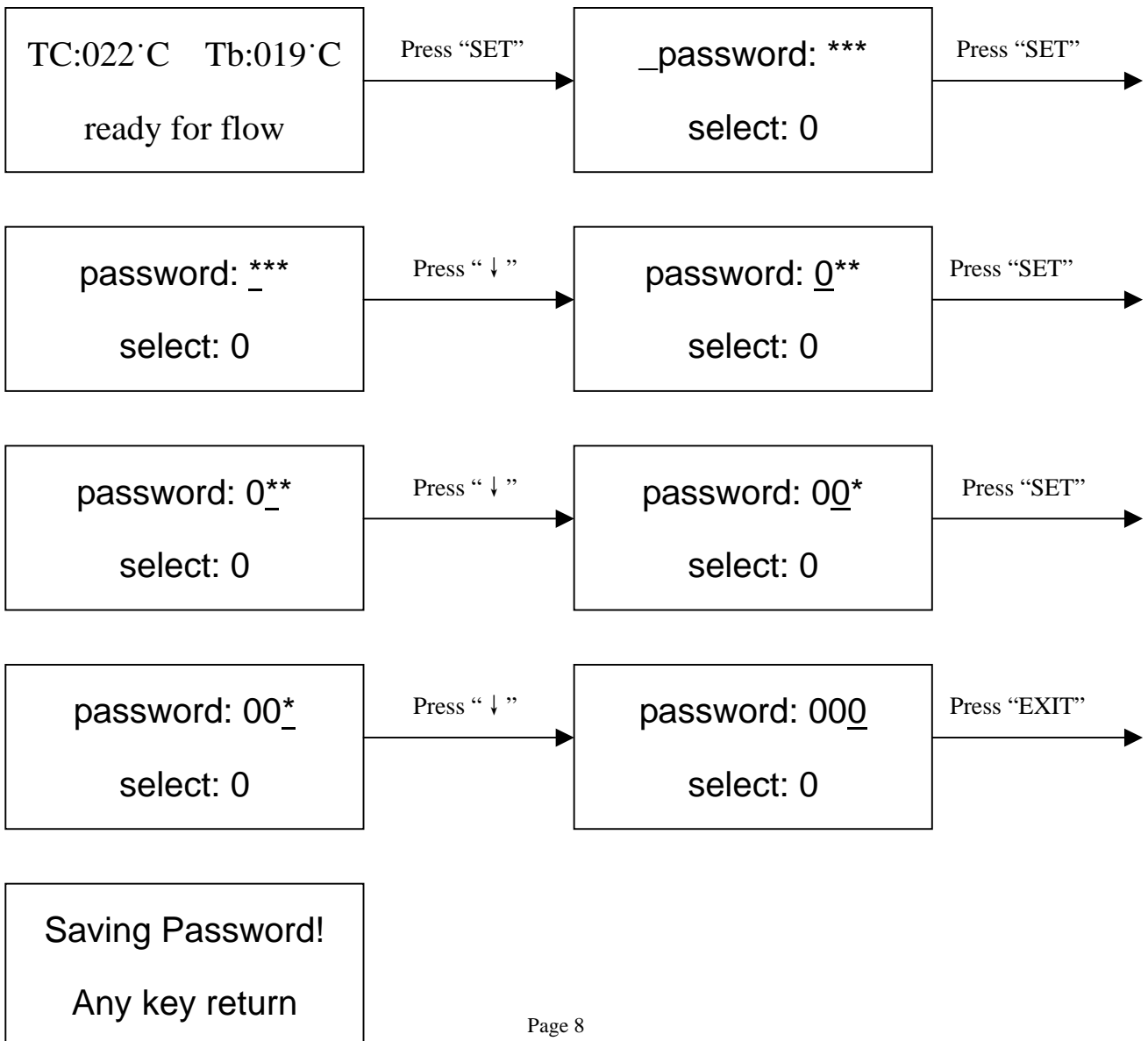

**Finish password inputting:**

1. If you want to modify the password, return to above mode to input the new password. If password is modified successfully, it will show:

**Saving Password!**  
Any key return

2. If you want to modify the next working flow, operate as the following B item; If you don't want to modify, please press “↓” key to browse the following parameter settings.

**B. Modify working flow**

**For instance: Modify the working flow and make it become 1 flow.**

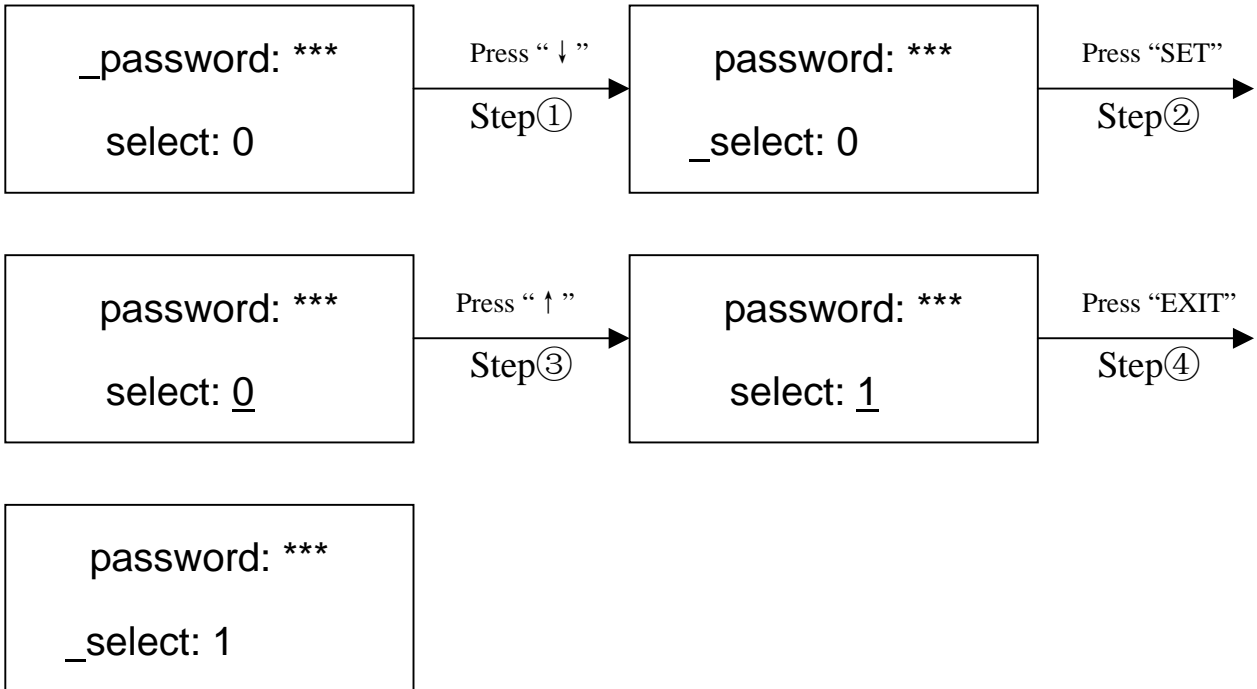

1. When carry on the forth step (Step④), if press “SET” key, you can browse and modify parameter of this flow, shown as C-1 item.
2. After finishing modifying of working flow 1, if you want to modify the next working mode, operate as C item shows; If you don't want to modify it, you can press “↓” key to browse the next parameter settings.

**C. Modify working mode**

**For instance: Modify the working mode and make it in “desolder” mode.**

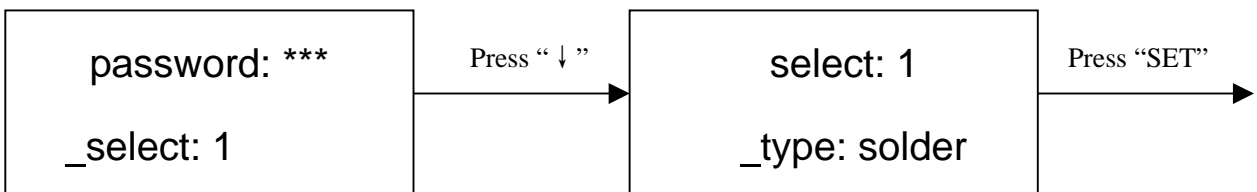

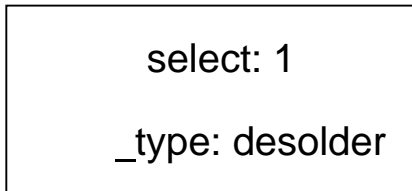
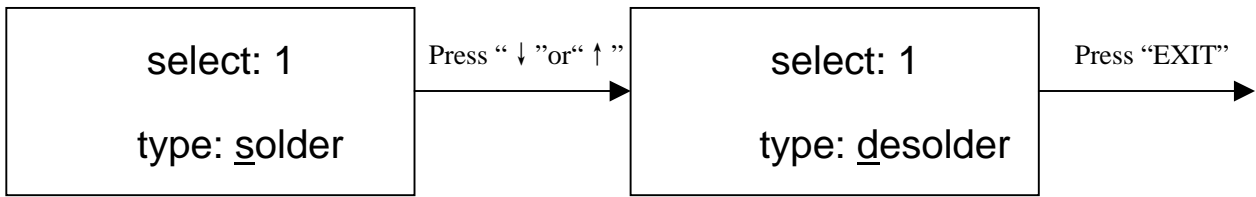

After finishing modifying working mode, if you want to modify laser alignment mode, operate as D item shows; if no need to modify it, please press “↓” key to browse the next parameter settings.

### C-1. Modify Parameter of working flow

1. If it is necessary to modify parameter of a working flow, first you must select the working flow and then modify its parameter.
2. The modification of parameter must accord with the following technics graph.

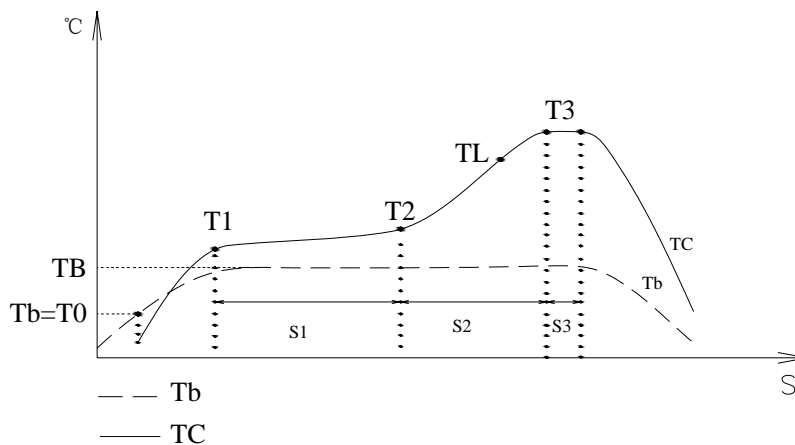

The soldering technics is decided by T0, TB, T1, T2, T3, S1, S2 and S3. It describes the temperature graph during the system working. TL denotes Melting temperature of solder and the range between T2 and T3.

#### T0

T0 is the valve temperature for bottom heater required by top heater when it heats up. Also it is the first temperature of this technics process. When the work flow begins, the bottom heater starts to heat up. After reaching the T0, the top heater begins to heat up.

#### TB, Tb, TC

TB: The setting temperature of bottom preheating Tb: Real-time temperature of bottom heating TC: Real-time temperature of top heating

#### T1

It is the heat preservation starting temperature of reflow soldering. It is the second temperature of this

technics process. The temperature rises to T1 with a proper speed the component permits. In parameter modifying, use the “↑” and “↓” key to set the value of T1.

#### T2

It is the temperature when finish the heat preservation of reflow soldering. The pre-heating temperature rises to T2, after the time of S1 finishes. Within this time, PCB and component pre-heating is finished and the solder is activated. In parameter modifying, use the “↑” and “↓” key to set the value of T2.

#### T3

It is the peak value temperature of reflow soldering. When the temperature reaches T2, the temperature equably rises to T3 with a definite raising speed. The soldering or de-soldering will be finished when the temperature reaches to the peak value and performs the next step. In parameter modifying, use the “↑” and “↓” key to set the value of T3.

#### TL

Melting temperature of solder. At this temperature, the solder starts to melt down and turn into liquid. During the soldering and de-soldering, users can press “CAL<sub>TL</sub>” Key to calibrate the value of TL when the solder turn into liquid. In parameter modifying, use the “↑” and “↓” key to set the value of TL.

#### S1

Heating time rising from T1 to T2. User can set the value in the range of 0~300s.

#### S2

Heating time rising from T2 to T3. User can set the value in the range of 0~300s.

#### S3

Prolonged heating time (Heat preservation time) after the temperature reach T3, and user can also set the value in the range of 0~300s.

#### Unit

It's able to set the unit of display temperature during work flow. In parameter modifying, use “↑” and “↓” keys to set the value of it.

#### Sense

It is used for choosing the system's sensor type. Users can also choose K type sensor used for measuring temperature, besides system's IR sensor. The signal of chosen sensor will be displayed and used for process controlling. In parameter modifying, use the “↑” and “↓” key to set the value.

#### Password

It is used for setting password. It is designed for preventing the equipment unnecessary or non-authorized change. When it is set to “000”, the password protecting is useless. The password is used for all flows and it can be useful and useless in each flow. The system requires inputting correct password before any change. Using of password refer to A item.

**For instance : Modify parameter of flow one and make T1=130°C, S1=70s, T2=160°C, S2=50s, TB=130°C. (Flow one has been selected)**

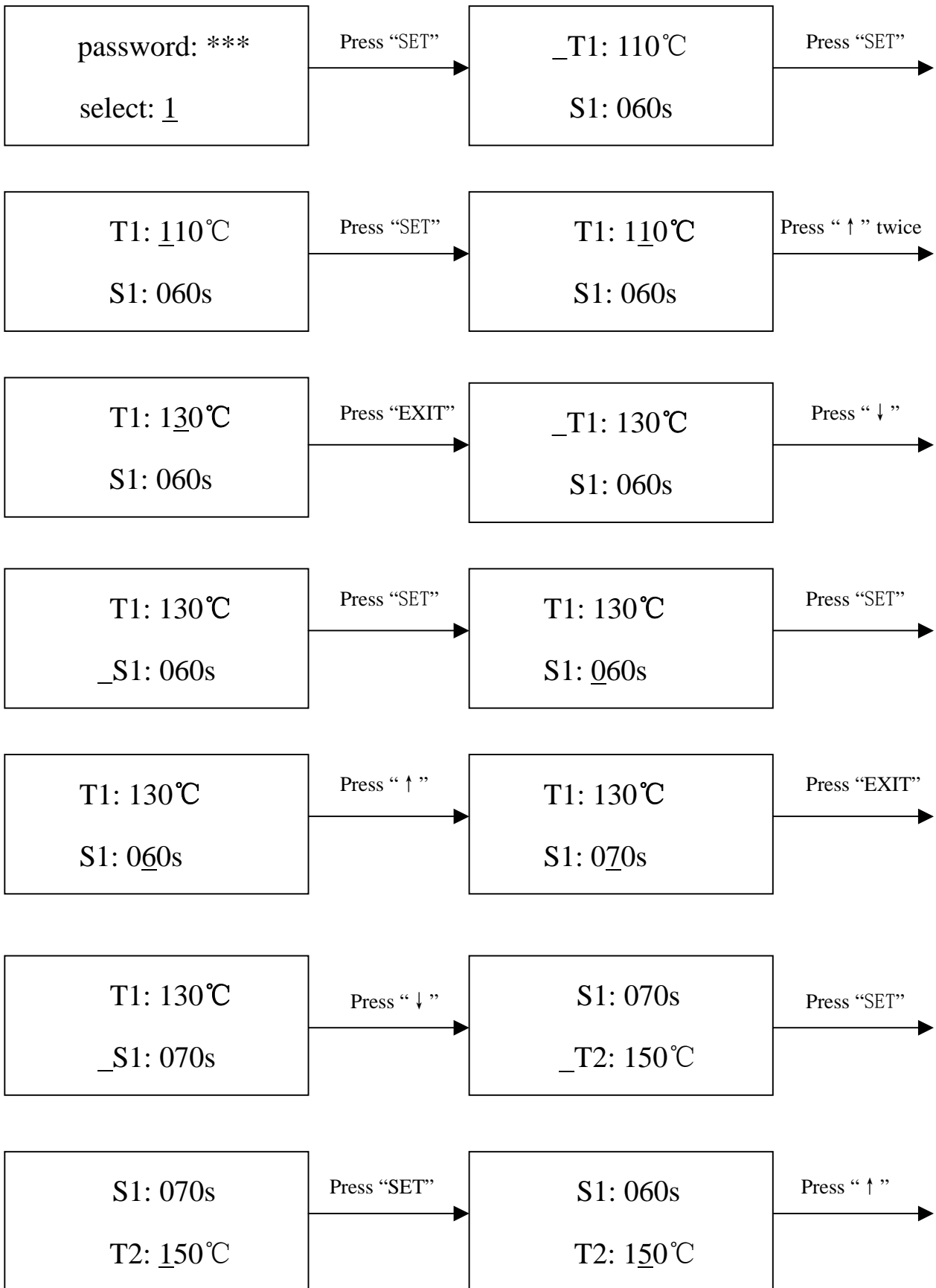

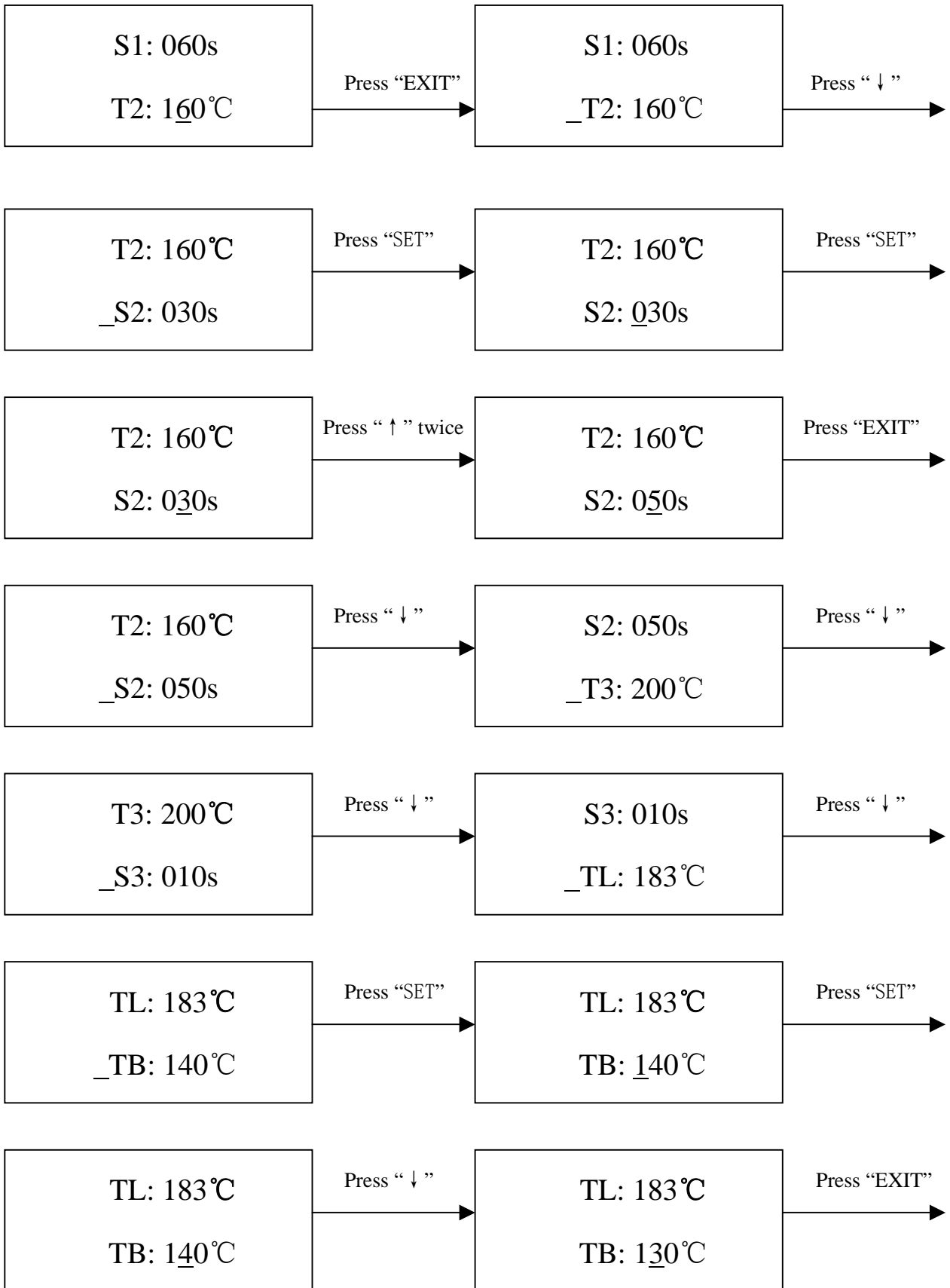



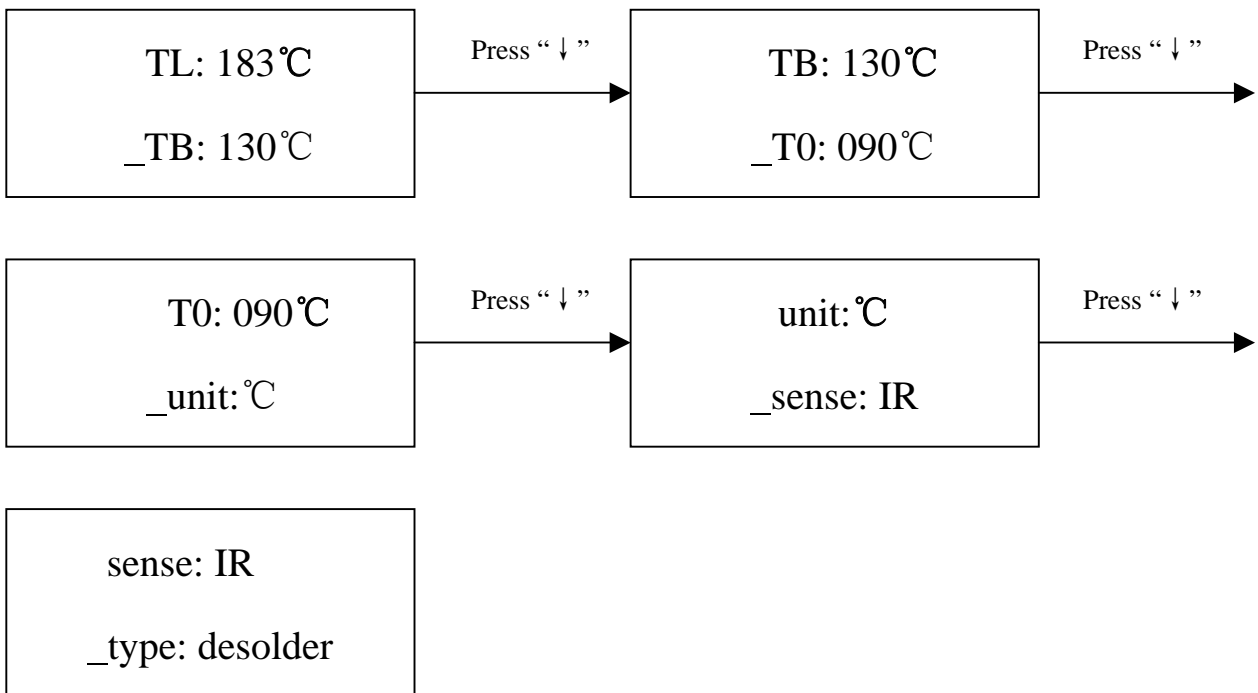

#### D. Modify laser alignment mode

For instance: Modify the laser alignment mode and set it to “on”.

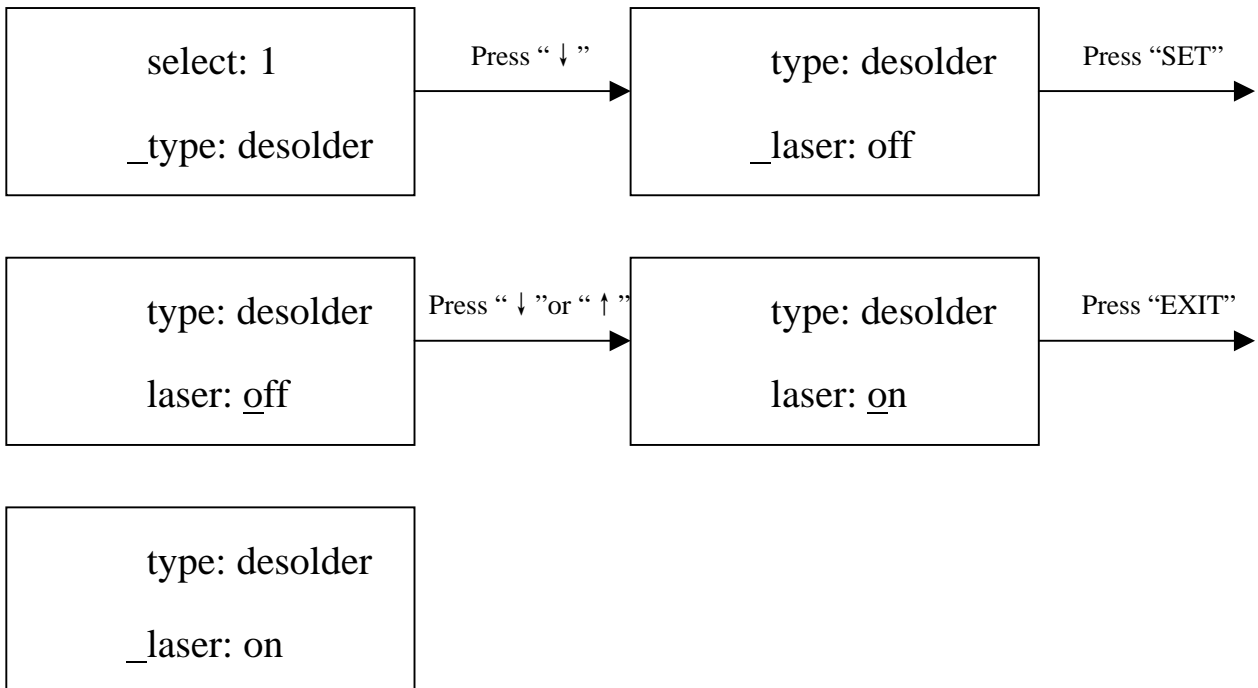

1. After finishing the modification, the next step communication speed, will not be able modified by keyboard.
2. Press “EXIT” to exit. Now, the system has saved all parameter settings, IR window will display:

TC:022°C Tb:019°C

ready for flow

- After all technics parameters have been selected, press “BEGIN” key and the system perform the set flow.

## E. System instruction

- In initial state, if the top sensor or outer sensor is broken, it displays:

TC: \*\*\*°C Tb: \*\*\*°C

T sense error !

If the bottom sensor is broken, it displays:

TC: \*\*\*°C Tb: \*\*\*°C

B sense error !

If above status happens, user should stop operating.

- During movement upward and downward of top IR heater or holding out and drawing back of fan arm, if it doesn't reach over 10 seconds, the unit will come back to initial state all and singular in spite of what state it is here. It displays:

TC: \*\*\*°C Tb: \*\*\*°C

Move error !

And stop any mechanical moving until rerunning the unit.

- During the working process, when the TC is below 180°C and the upper temperature is less than 7°C in ten seconds, the system will exit the process and display “TC raise error”.
- During the working process, the system will exit the process and display “TC over error” when the TC is over 265°C

## 4.6 Operating technics instruction



Note: Top and bottom IR radiator will be very hot during working, so please don't touch the hot housing parts.



Note: The laser alignment device includes a secondary laser device, so don't see the laser beam directly.

#### 4.6.1 Instruction of soldering operation (Switch on the system's power)

1. Turn on power switch of each part.
2. Move PCB Fixture with fixed PCB to make PCB over the Bottom Heater and make the soldered component between Top Heater and Bottom Heater. The position is easy to be measured with laser alignment device. The right position should make the red laser point in the center of component. The component which to solder on the PCB have been aligned before soldering. Suggest to use PL2005 precision placement system.
3. Adjust aperture system to get a proper window size.
4. Adjust RPC in appropriate place, adjust size and focus of image with PL keyboard to display component image in the monitor clearly.
5. Select parameter with keyboard. (Refer to "Parameter setting")
  - A. Input password "000"
  - B. Select the required flow, if need to modify, perform relevant operation.
  - C. Select "solder" working mode.
  - D. Select "IR" laser alignment mode.
  - E. No change to communication speed, and press "EXIT" key to exit. IR window shows:

TC:022°C Tb:019°C

ready for flow

- F. Press "BEGIN" key and the system start to work, perform content of selected flow.
6. IR window will show series of setting temperatures and the current temperature of Tb and TC during working, and indicate when it reaches T0, T1, T2, T3 and TL. S1, S2 and S3 are counted down and user can know about the setting value clearly.
7. If you see the solder has melted down (It is watched with IR camera and LCD), you can press "CAL<sub>TL</sub>" Key to calibrate temperature of TL to adjust the display temperature to liquid temperature TL.
8. When the temperature reaches TL, there will be a voice signal.
9. When the temperature reaches T3, the voice signal is change to a hurry sound and the system prolongs heating by S3 seconds, after it, the system will not heat up anymore, and the technical process is over.
10. The system can perform a series of function action during working.
  - A. After press "BEGIN" key, the top heater move downwards near to bottom.
  - B. After the system sounds unvaryingly, the top heater move upwards and cooling fan spread out to blow cooling wind.
  - C. After 150 seconds, the cooling fan stop blowing and the soldering technics has finished.
11. The cooling fan stop working and the whole process has finished.

## 4.6.2 Instruction of de-soldering operation (Switch on the system's power)

1. Turn on power switch of each part.
2. Fix the PCB on the top of bottom heater and make the de-soldered component between top heater and bottom heater. The position is easy to be measured with laser alignment device. The right position should make the red laser point in the center of component and the suction pad also in center of component.
3. Press the vacuum suction tube to check whether suction pad is in the center of component. (If the deflection is too much, the tube will not be able to pick up the component.)
4. Adjust aperture system to get a proper window size.
5. Adjust RPC in appropriate place, adjust size and focus of image with PL keyboard to display component image in the monitor clearly.
6. Select parameter with keyboard. (Refer to "Parameter setting")
  - A. Input password "000"
  - B. Select the required flow, if need to modify, perform relevant operation.
  - C. Select "desolder" working mode.
  - D. Select "IR" laser alignment mode.
  - E. No change to communication speed, and press "EXIT" key to exit. IR window shows:

TC:022'C Tb:019'C

ready for flow

- F. Press "BEGIN" key and the system start to work, perform content of selected flow.
7. After pressing "BEGIN" key, bottom heater starts to heat up and top heater moves downwards and reach to bottom.
8. IR window will show a series of setting temperatures during working. Indicate when it reaches T0, T1, T2, T3 and TL. When the bottom temperature reaches T0, the top heater begins to heat up.
9. When the temperature reaches TL, it will give a sound alert automatically (Low frequency).
10. When the temperature reaches T3, it will also give a sound alert automatically. (Middle frequency)
11. When the solder has melted down, press the vacuum suction tube to pick up the component.
12. Press the vacuum suction tube, the vacuum pump start to work and pick up component, then return to original position. The system stops heating.
13. The top heater moves upwards and stops at top.
14. Cooling fan spreads out to blow cooling wind.
15. 90 seconds after the top heater moving upwards, the vacuum suction tube loses component automatically.
16. After cooling fan blowing cooling wind for 150 seconds, the whole soldering technique has finished.

## 4.7 Turn off the equipment

Please turn off power switch of each part and pull out power plug when not using it.

## 4.8 Equipment Maintenance

### Remark:

For ensuring reliable function and maintenance of equipment, please use parts provided by original factory.



### Note:

After cutting off the power supply, the housing is still very hot, so please don't use any dangerous or combustible solvent to clean it.

### Clean parts:

Suggest to use dry or wet towel to clean the equipment. Solder on the gridding can be cleaned out with hard object.

### Replacement of suction pad:

If you want to replace the suction pad, please turn off power, and replace it after waiting for vacuum suction nozzle and top heater to cool down.

Take suction pad out of suction nozzle downwards, and install a new one in opposite direction.

## 5. Instructions of PL2005 Precision Placement System

### 5.1 Specification

- |   |  |
|---|--|
| 1.Power consumption:  | about 15W  |
| 2.Fuse:   | 1A (110V), 0.5A (220V)   |
| 3.Camera:   | 12V/300mA<br>Magnification: 22×10times<br>Horizontal resolution is 480 TV lines<br>Signal type PAL composite |
| 4.Vacuum pump:  | 12V/600mA, 0.05Mpa (Max)   |
| 5.LED lighting:   | White LED down and red LED up with adjustable brightness   |
| 6.Keyboard:   | 8 keys   |
| 7.Upward and downward movement range:   | 93mm   |
| 8.Upward and downward movement motor:   | 24VDC/100mA  |
| 9.Weight:   | 22Kg   |
| 10.Vacuum pencil is controlled by on and off switch   |  |
| 11.Camera on PL and IR is controlled by telescopic arm. Brightness of IR camera will be controlled by keyboard of PL. |  |
| 12.Camera output signal is video signal   |  |

**Note:**

- \* When purchasing the equipment, please point out the work voltage.
- \* PL camera has been calibrated accurately before leaving factory.

## 5.2 Picture

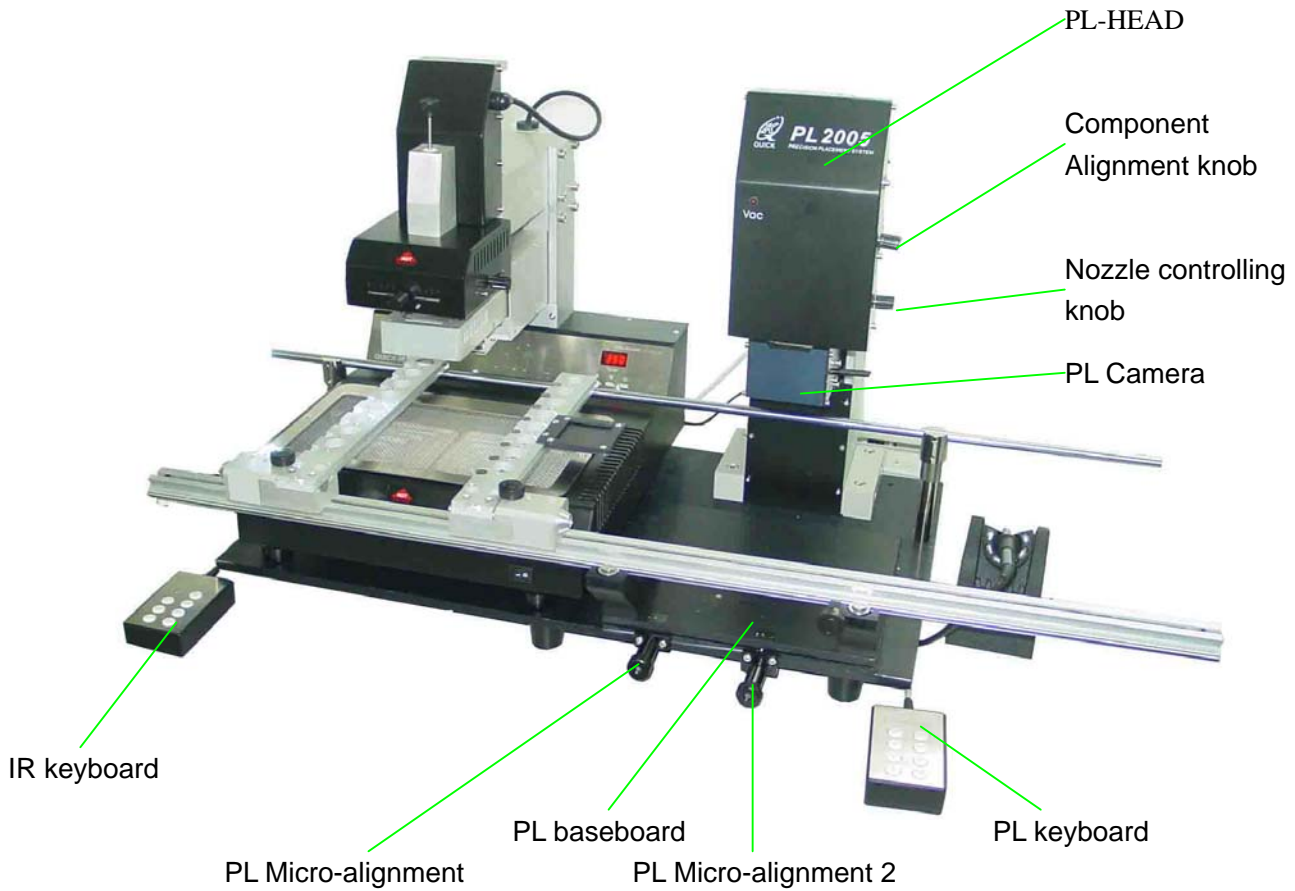

## 5.3 Placing equipment

\* Unpack the packaging and take out equipment, then place it onto a stable level table.

## 5.4 Install and connect equipment

**Note:**

- \* Make sure the unit is in good condition and check whether the voltage used accords with rated voltage on the equipment nameplate.
- \* Take out the setscrew on the movement arm of PL camera, before installing the equipment.

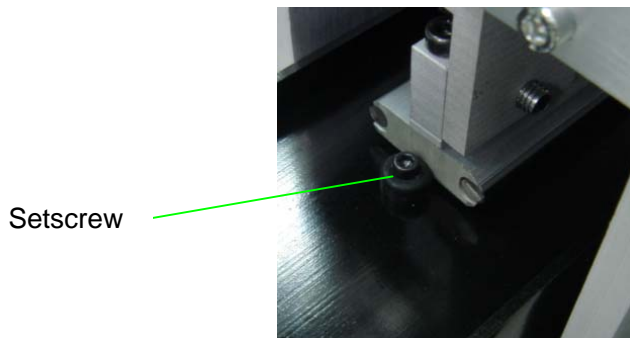

### 5.4.1 Install RPC

1. Install RPC fixing bracket to the bottom of PL baseboard and tighten the fixed screw in the bush.

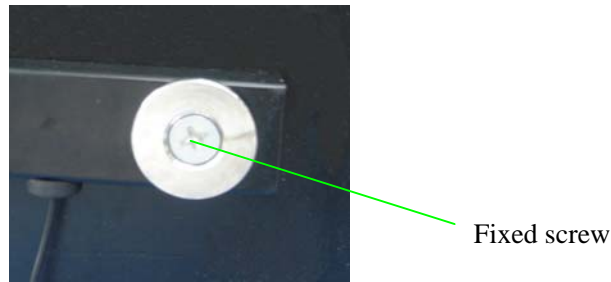

2. Unscrew the RPC fixed knob on the bracket and install RPC on it, tighten knob.

3. Put the plug of RPC connecting lead into socket.

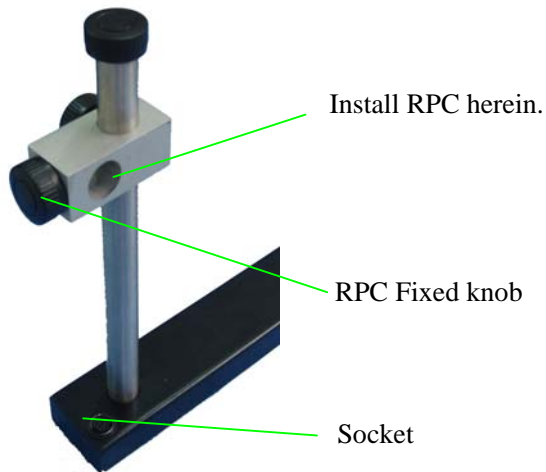

**RPC Fixing Bracket**



**RPC**

### 5.4.2 Placing IR2005 system

There are four locating points on the left side of PL 2005. Place the IR 2005 rework system onto the left part of PL 2005, and make four support pins match PL 2005 four locating points.

### 5.4.3 Connect parts

1. Put the plug of display into the display connection socket behind equipment.
2. Put the plug of IR camera into its camera socket and its video socket.
3. Put the plug of PL camera into its camera socket and its video socket.

Please refer to the following picture.



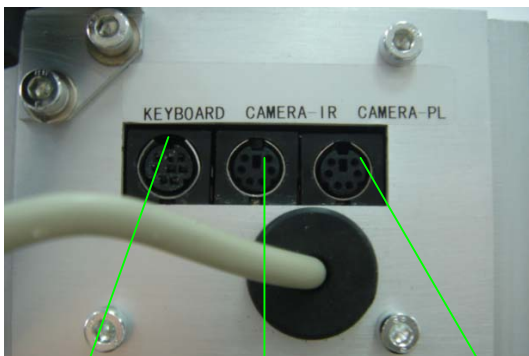
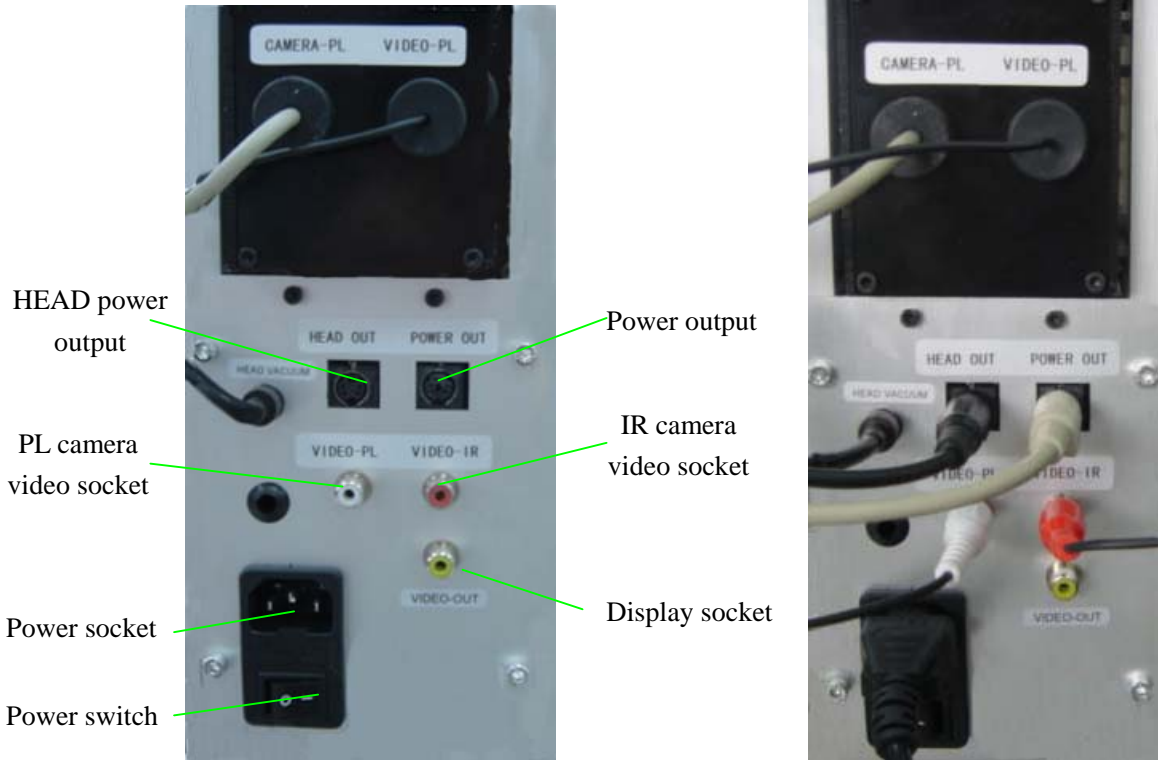

PL keyboard socket      IR camera socket      PL camera socket



IR camera socket



## 5.4.4 Connect Power

Put the connector of power cord into power socket behind equipment, and put the plug into three-terminal grounding power socket to switch on power.

## 5.5 Instructions of keyboard and parts

### 5.5.1 Instructions of keyboard function

1. When PL camera is pulled out, keyboard only controls PL camera and its lighting. PL-head's (placement head) upward and downward movement is forbidden. Key “↑” and key “↓” are useless.
2. When PL camera is retracted inside, keyboard only controls reflow camera of BGA-IR and its lighting. PL-head's upward and downward movement is allowed. Key “↑” and key “↓” can control upward and downward movements of PL-HEAD.
3. When PL camera is pulled out, press “LIGHT B” + “↑” keys simultaneously to increase the brightness of PL bottom light; press “LIGHT B” + “↓” keys simultaneously to decrease the brightness of PL bottom light; press “LIGHT T” + “↑” keys simultaneously to increase the brightness of PL top light; press “LIGHT T” + “↓” keys simultaneously to decrease the brightness of PL top light.
4. When PL camera is retracted inside, press “LIGHT B” or “LIGHT T” + “↑” keys simultaneously to increase the brightness of RPC light. Press “LIGHT B” or “LIGHT T” + “↓” keys simultaneously to decrease the brightness of RPC light.
5. “ZOOM+” and “ZOOM-“ keys are used for controlling zooming of image.
6. “FOCUS+” and “FOCUS-“ are for the camera focusing purpose.
7. “↑” and “↓” key is for controlling upward and downward movement of PL-HEAD.

### 5.5.2 Instructions of parts

#### 1. PCB fixture

Movable PCB fixture is able to fix different size PCB. It has three locknuts. Two locknuts are used for locking PCB clamp bar to prevent it from unnecessary moving. The third fixture locknut is used for locking orbit to prevent fixture from unnecessary moving.

Unscrew PCB locknuts and push the sliding block by hand to open the PCB clamp bar, make the distance between them accord with PCB size. Fix PCB between them and screw down PCB locknut after adjusting position. If you want to lock PCB fixture, please screw down fixture locknut.

We suggest that when you fix PCB, make PCB be fixed in the middle of Orbit.

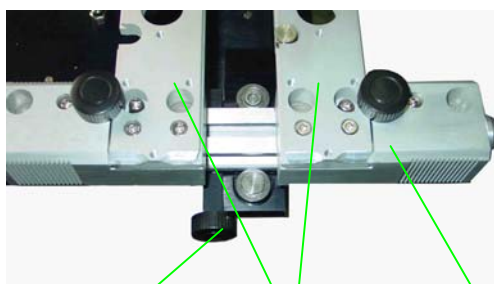

Fixture locknut PCB clamp bar Sliding Block

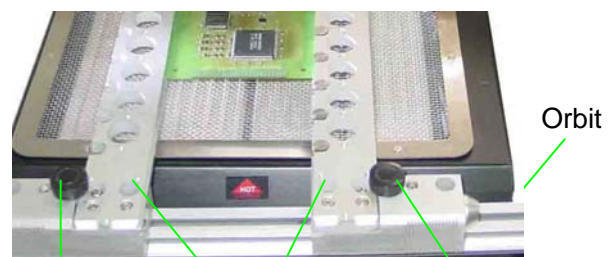

PCB locknut Insert PCB from here PCB locknut Orbit

## 2. Adjustment knobs

There are two adjustment knobs on PL-HEAD, one is component aligning knob, and the other is nozzle controlling knob.

Turn nozzle controlling knob to make the vacuum nozzle move up and down. As soon as the vacuum nozzle touches component, the vacuum pump starts to work and pick up component. Turn it clockwise for up movement and turn it anticlockwise for down movement.

Turn component aligning knob to make nozzle turn, and change the position of component to realize the alignment purpose. Direction of turning knob accords with nozzle turning.

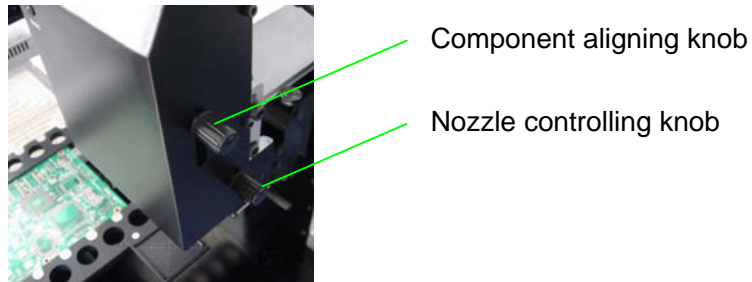

Turn “PL Micro-adjustment knob1 to make PCB fixture move right and left for adjusting PCB’s right and left position. Turn it clockwise for rightwards move and turn it anticlockwise for leftwards move.

Turn “PL Micro-adjustment knob2 to make PCB fixture move forward and backward for adjusting PCB’s front and rear position. Turn it clockwise for forward move and turn it anticlockwise for move backward.



## 3. IR Camera (RPC)

IR camera position can be adjusted. First, unscrew Fixed Knob in corresponding direction and then adjust. IR camera can move up and down or turn.



#### 4. PL Camera

It needs to use IR camera during the component aligning. PL camera will transmit the image of soldering point on PCB and component pins under nozzle to display through video signal and user can see these images on display screen. At the moment, you can use every adjusting function to align component.

It needs to completely pull out PL camera when using it. At this time, the image displayed is got by PL camera. When not in use, push it back, and the image displayed is got by IR camera.

When PL camera is pulled out, LED brightness of PL camera can be adjusted by keyboard. Press “LIGHT B” + “↑” keys simultaneously to increase the brightness of PL bottom light (white light); Press “LIGHT B” + “↓” keys simultaneously to decrease the brightness of PL bottom light (white light); Press “LIGHT T” + “↑” keys simultaneously to increase the brightness of PL top light (red light); Press “LIGHT T” + “↓” keys simultaneously to decrease the brightness of PL top light (red light).

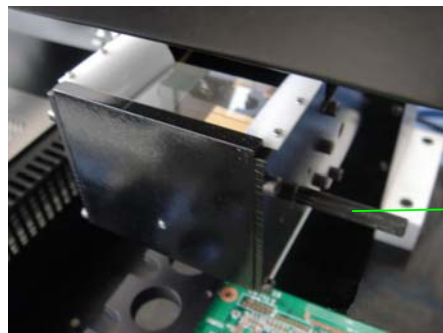

Pull and push the pole by hand

### 5.6 Aligning operation Instructions (Switch on the system's power)

1. Turn on power switch of each part.
2. Press “↓” key to make PL-HEAD move down.
3. Place the soldered component into the center of salver, move PCB fixture to make the vacuum pen aim at component on the salver. Turn the nozzle controlling knob to make nozzle move down to pick up component. The component should be picked up from its center. As soon as the vacuum nozzle touches component, the vacuum pump starts to work and pick up component.

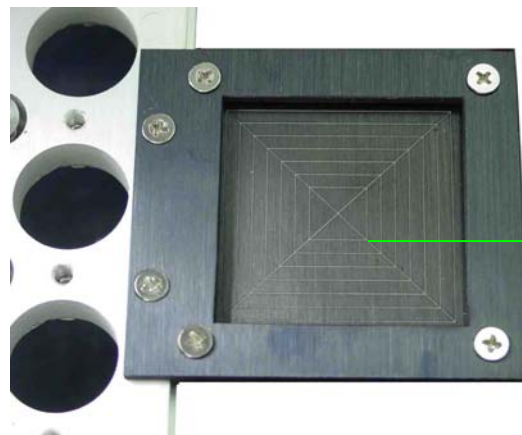

Salver

4. Press “↑” key to make PL-HEAD move up.
5. Pull out PL camera.
6. Check whether the image display on the display accords with user's demand. Use keyboard to adjust it.

- Refer to “Instruction of keyboard function”.
7. Unscrew the PCB locknuts on the PCB fixture to open PCB clamp bar. Fix the soldered PCB on PCB fixture and adjust PCB’s position. Make the screen display the image of soldering point, and make the images of soldering point image and component have the same center. It is convenient for adjusting. After roughly adjusting, screw down fixture locknut to lock PCB fixture to prevent it from sliding right and left.
  8. Align the component with four adjustment knobs. Make the images of component solder pins image and the soldering point on PCB superpose. The image can be observed on the display. Aligning adjustment refer to “Adjustment knobs”.
  9. Push back PL camera after aligning.
  10. Press “↓” key to make PL-HEAD move down.
  11. Turn the nozzle controlling knob to make the nozzle move down for placing component on PCB. Once the component touches PCB, the vacuum stop working and make the component is placed.
  12. Unscrew fixture locknut and move PCB Fixture to make PCB under the Top Heater of IR2005 for soldering. At the moment, the whole aligning operation is finished.

## 5.7 Turn off the system.

Please turn off power switch of each part and pull out power plug when not in use.

## 5.8 Calibrating the system

Due to vibrations during the transport, it is necessary to calibrate the system before use. The steps are shown as follows.

### 5.8.1 Checking the calibration

1. Insert the calibration plate into the PCB fixture and adjust the position, lock the fixture.
2. The vacuum tube section of vacuum pump will be treated as the calibration hole. (If it has nozzle, please remove it.)
3. Press “↓” key to make PL-HEAD move down.
4. Turn “Nozzle controlling knob” to lower the calibration tube. Check whether the calibration tube superposes exactly with the round hole on the calibration plate. If they don’t superpose, please adjust Micro-adjustment knobs of fixture until the calibration tube and hole completely superpose. After this, please make sure there will be no any change to the calibration plate or calibration tube.

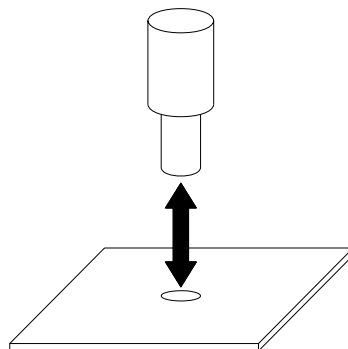

5. Press “↑” key to make PL-HEAD move up.
6. Pull out PL camera and adjust the image display by keyboard. Observe the images: if the two images (round) on the display superpose, the system is precise. If not, the system is imprecise, it needs to be adjusted.

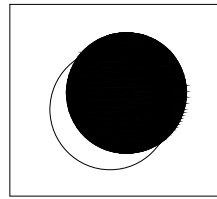

Imprecise

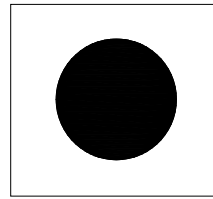

Precise

### 5.8.2 Adjusting the alignment

1. Unscrew the fixation screw of the camera box on both sides.

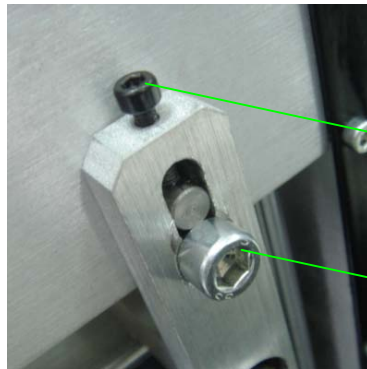

Adjusting screw

Fixation screw

2. Using spanner to adjust the two adjusting screws on fixed screws, the adjustment extent can't be too large, until the two round images on the display superpose.
3. After superposing, screw down fixation screws on both sides. After screwing down, the image of display is superposed too.
4. If necessary, you can repeat the above steps to calibrate once again.

## 5.9 Equipment Maintenance

### Remark:

For ensuring reliable function and maintenance of equipment, please use parts provided by original factory.

### Clean parts:

Clean the dust on system with clean towel.

Clean the prism of PL camera with pledget and be careful not to scrape it.

Add oiling in axletree and gear periodically.

Use the towel with cleaning oil to clean PCB fixture and orbit.

**Note:** PL2005 is a precise equipment. Please don't do any alteration to it, otherwise, the precision of this equipment will be affected.